

4SEQ Build guide & BOM

vers1 (2/6/2015)

This sequencer is a minimalised hybrid of the bindubba 1 & 3 sequencers. It features forwards and backwards stepping plus the CV outputs step in opposite directions to each other. There is also a clock divider giving /2, /4, /8 & /16 divisions of the incoming clock signal.

The chart shows how CV outputs X & Y differ from each other over 8 clock signals, with the pots set to give 1-4V.

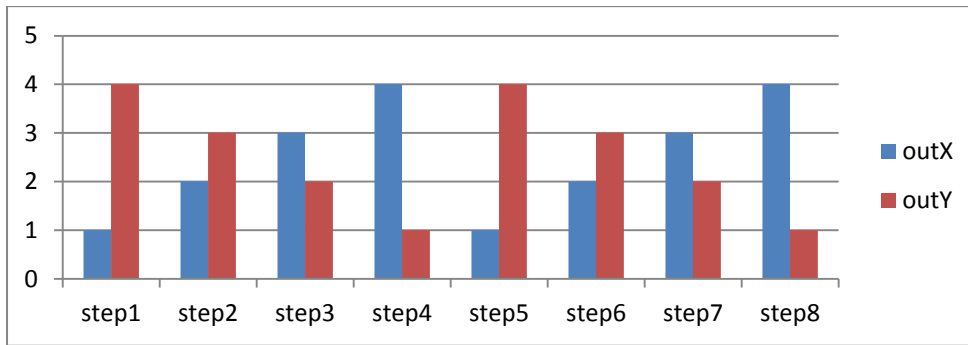

When a gate is introduced to the u/d input, it is possible to create sequences of greater complexity.

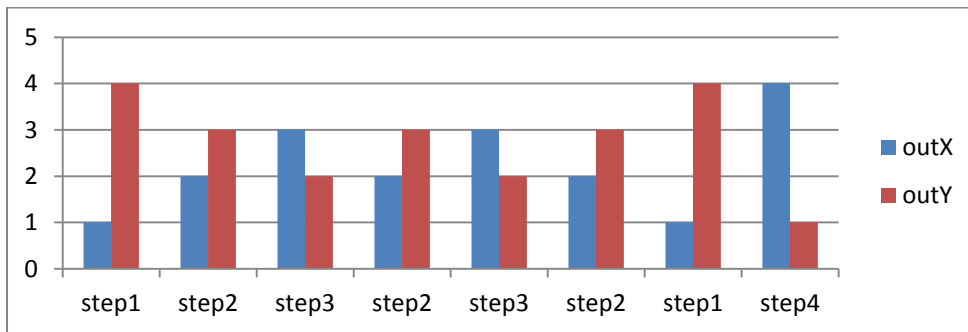

Although gate and trigger signals are preferred, any signal crossing 1V will trigger the clock or u/d inputs. Some complex waveforms may cause erratic behaviour, which might be a good thing.



Building

It is best to install the 1206 or 0805 components on the back of the PCB first, and then install the 1206 or 0805 components on the top of the PCB. After this install the sockets, power pins and thru-hole components.

Connect the pots and LEDs to the back of the PCB, but do not solder them. Regarding the LEDs; the long lead goes into the square hole marked 'A'. Attach the jacks to the panel, so the ground tabs are oriented correctly. Mate the panel to the PCB, ensure everything lines up properly, place the nuts on the pots, and then solder everything on. Use some wire clippings to connect the jack ground tabs to the PCB.

For the LEDs, you may need to change the value of the current limiting resistors; these are all marked as 1k on the PCB, but please check the images after the BOM to see which resistors you will need to change.

BOM

component	quantity	remarks
4052	1	DIP cmos
4029	1	DIP cmos
TL074	1	DIP
TL072	1	DIP
BC547	4	NPN thru-hole
1N4148	2	thru-hole
LED	4	5mm size
jacks	8	 Kobiconn style
100k pots	4	
100nF capacitor (or larger) (‘104’ on PCB)	3	1206 or 0805, for decoupling so up to 10µF okay
10R	2	thru-hole
1k (‘1’ on PCB)	14	1206 or 0805
10k (‘d’ on PCB)	3	1206 or 0805
100k (‘c’ on PCB)	15	1206 or 0805
16 pin IC socket	2	
14 pin IC socket	1	
8 pin IC socket	1	
eurorack power connector (10 pins)	1	

To change the 4 LED resistors:

on the top of the PCB:

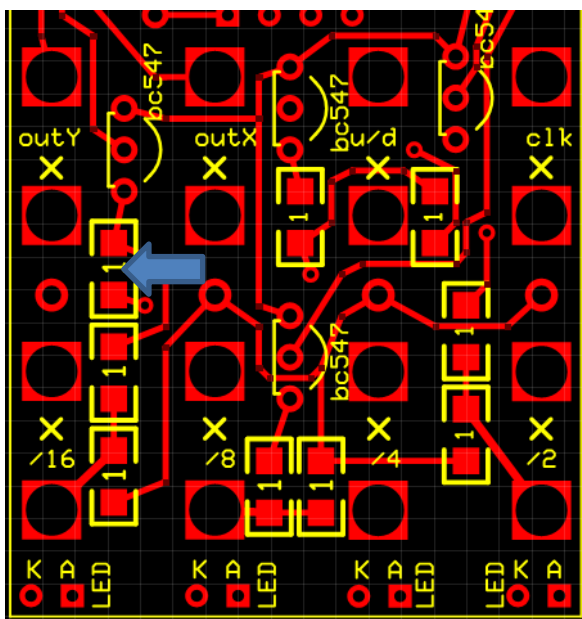

on the bottom of the PCB:

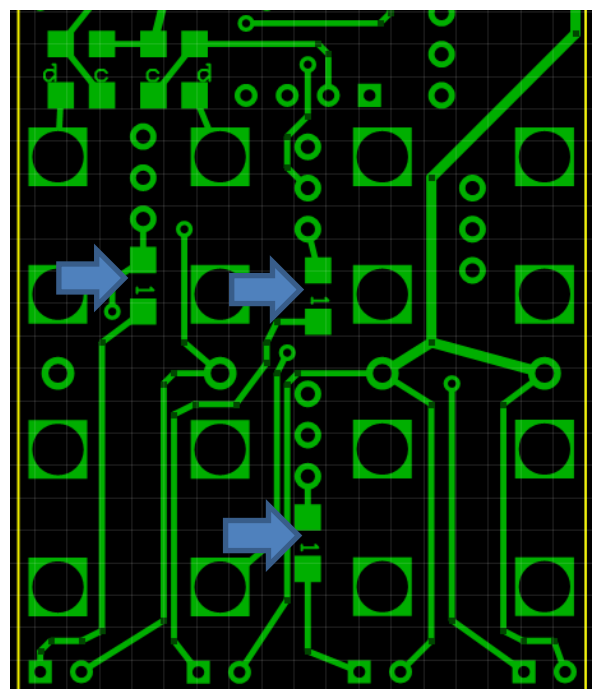

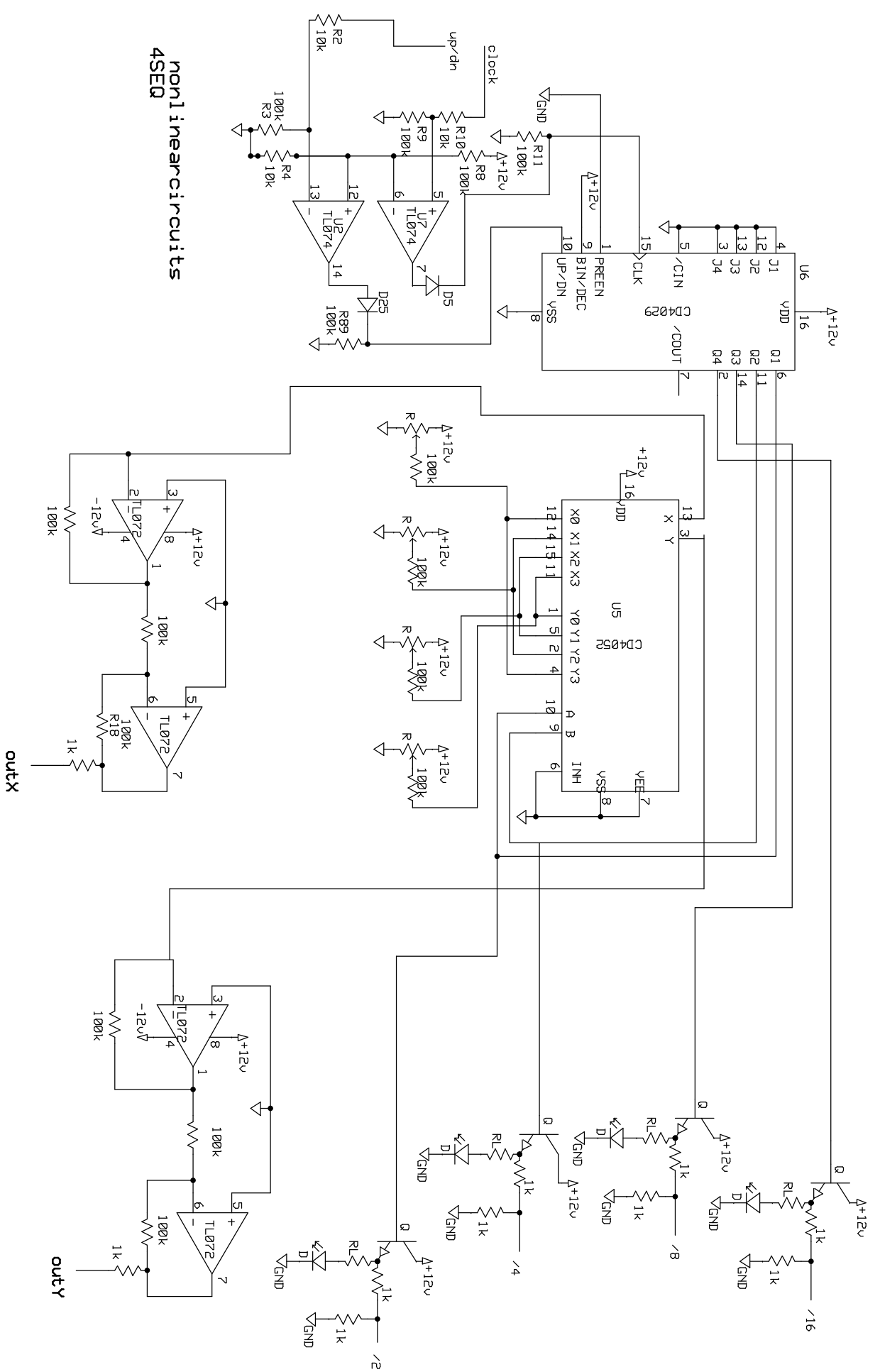

nonlinear circuits
4SEQ

outX

outY