

ROTARY SWITCH

MODEL

SR2611F-0112-(L)ROB-D8-N

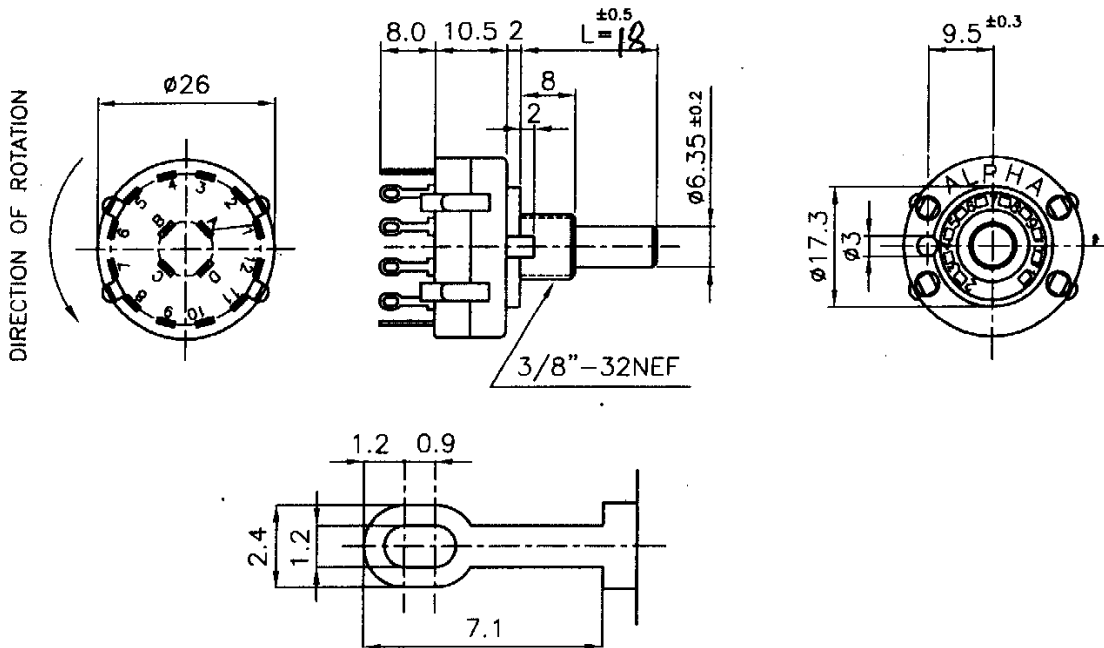

SPECIFICATIONS

Rating	AC125V 0.3A
Contact Resistance	50 mΩ Max.
Insulation Resistance	DC500V-100 MΩ Min.
Withstand Voltage	AC500V-1 Minute
Rotation Torque	0.5±0.2 Kg-cm



DETAIL OF TERMINAL(5/1)

- NOTE:
1. TOLERANCES UNLESS OTHERWISE SPECIFIED: ±0.4mm
 2. ACCESSORY PARTS: 3/8" HEXAGON NUT ONE PIECE & LOCKWASHER ONE PIECE.
 3. TIMING: NON-SHORTING

Date	2009.06.11	DWN		CHKD		APP'D	
------	------------	-----	---	------	--	-------	---

	Specification Rotary switch SR26XXF	DOC. No: Rev. A
		Date:
		Author: 何建志
		Approved: 王茂松

CONTENTS 内容

Section	Description	Page
1.0	Test Conditions	2
2.0	Outside Dimension	2
3.0	Mechanical Performance	2-3
4.0	Electrical Performance	3
5.0	Endurance Performance	3-4
6.0	Note	4

	Specification Rotary switch SR26XXF	DOC. No: Rev. A
		Date:
		Author: 何建志
		Approved: 王茂松

1. TEST CONDITIONS

Standard test conditions shall be 5-35°C in temperature and 45-85% RH in humidity.
 Should any doubt arise in judgment test shall be conducted at 20±2°C and 65±5% RH.

2. OUTSIDE DIMENSION

Append drawing.

3. MECHANICAL PERFORMANCE

Item	Test Condition	Specification
3.1 Operating force	Operation temperature:-10°C ~ +70°C Storage temperature:-40°C ~ +85°C	0.5±0.2kgf-cm
3.2 Control strength	A static load of 1000gf-cm shall be applied in the operating direction and tensile direction of the unit for one minute.	N/A
3.3 Terminal strength	A static load of 1000gf-cm shall be applied to the tip of the terminal in a desired direction for one minute. The number of tests shall be one per terminal.	N/A
3.4 Control wobble	Shall be measured by applying a static load of 100gf-cm to the tip of control unit.	Less than 1 mm
3.5 Soldering	Regarding preheating, the entire flow duration should not exceed 2 minutes, and soldering surface temperature (undersurface of PCB) shall be settled within 100°C. Temperature of solder 260±5°C Duration of dipping 4±0.5 seconds	More than 90% of the dipped part shall be covered by solder

	Specification Rotary switch SR26XXF	DOC. No: Rev. A
		Date:
		Author: 何建志
		Approved: 王茂松

- | | | |
|-------------------------------|--|--|
| 3.6 Soldering heat resistance | Flow soldering condition:
to be performed in 4 ± 0.5 seconds
within $260\pm 5^{\circ}\text{C}$
Manual soldering condition:
to be performed in 3 ± 0.5 seconds Max
within $350\pm 5^{\circ}\text{C}$ | No abnormalities shall be observed in appearance and operation shall be assured. |
| 3.7 Shaft stopper strength: | N/A | More than 5kg-cm |
| 3.8 Bushing mount strength: | N/A | 5kg-cm min |

4. ELECTRICAL PERFORMANCE

Item	Test Condition	Requirement
4.1 Rating	N/A	AC125V 0.3A
4.2 Contact resistance	Shall be measured at $1\text{KHz}\pm 200\text{Hz}$ (Max 20mV, Max 50mA) or 5V DC, 1A by a voltage drop method	Less than $50\text{m}\Omega$
4.3 Insulation resistance	Shall be measured by applying 500V DC, between all terminals and between the terminal and the frame for 1 minute \pm 5 seconds	More than $100\text{M}\Omega$
4.4 Withstand voltage	500V AC (50~60Hz, 2mA) Shall be applied between all terminals and between the terminal and frame for one minute	No function damage or breakdown.

	Specification Rotary switch SR26XXF	DOC. No: Rev. A
		Date:
		Author: 何建志
		Approved: 王茂松

5. DURABILITY

5.1 Operating life under no load

10,000 cycles of operation shall be performed continuously at a rate of 15-20 cycles per minute without load. After operating life test, shall be in accordance with the following specifications.

Contact resistance:
less than 80mΩ
Insulation resistance:
more than 50MΩ
Withstand Voltage:
250V AC per one minute
Operating force:
less than +10%,-30%
for initial operating force

5.2 Operating life under load

10,000 cycles of operation shall be performed continuously at a rate of 15-20 cycles per minute with resistive load of 125V AC, 0.3A. After operating life test, shall be in accordance with the following specifications.

Contact resistance :
less than 100mΩ

Other specifications are the same as operating life under no load.

6. NOTE

Terminals top side is covered by flux resist resin.

無鉛焊錫與保管條件共通規格書

Common Specification of Lead-Free Soldering and Storage conditions

以下焊錫條件以可變電阻置於單層 1.6mm 厚度之印刷電路板上測試為基準。

The specification below is based on testing results of 1.6mm thickness single layer printed circuit board.

1. 自動或半自動機台焊錫條件：

For Automated or Semi-Automated Soldering Equipments:

1.1 使用發泡式且比重 0.82 以上的助焊劑，發泡高度以印刷電路板厚度一半為標準，且助劑不能流入可變電阻基板表面及印刷電路板表面。

Flux of 0.82 specific gravity, applied by foam fluxer, shall be used. Foam head shall be limited to the height which is half thickness of printed circuit board to be soldered. No flux should be allowed to run up onto resistive element board of potentiometer and the surface of printed circuit board.

1.2 預熱時間不超過兩分鐘，焊錫接面（即印刷電路板底）最高預熱溫度不超過 100°C。

Regarding preheating, the entire flow duration should not exceed 2 minutes, and soldering surface temperature (undersurface of PCB) shall be settled within 100°C.

2. 手工焊錫、自動或半自動機台焊錫不得超過一回。

Regardless of soldering facility and method, solder dipping or solder smearing must not be carried out more than 1 time.

2.1 焊錫注意事項：

Caution for soldering:

如圖所示，請避免 PCB 上層表面有焊錫

Please avoid soldering on upper surface of P.C.B. as shown.

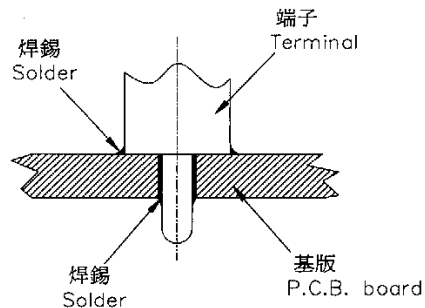

3. 保管條件(Storage conditions):

產品需儲存在原始的包裝，以及保持常溫常濕、避免陽光直射、遠離任何腐蝕性氣體。產品需盡快完全地使用完，建議最慢不要超過交貨後 6 個月。產品經拆封後，全部的數量都需迅速地使用完。

The products shall be stored in the original packaging and kept at room temperature and humidity, out of direct sunlight, and away from any and all corrosive gas. The products shall be completely used as soon as possible, but no longer than 6 months from the date of delivery. Once product packaging is opened, the complete quantity of such products shall be promptly used.